

## Installation Instructions: Air Transfer

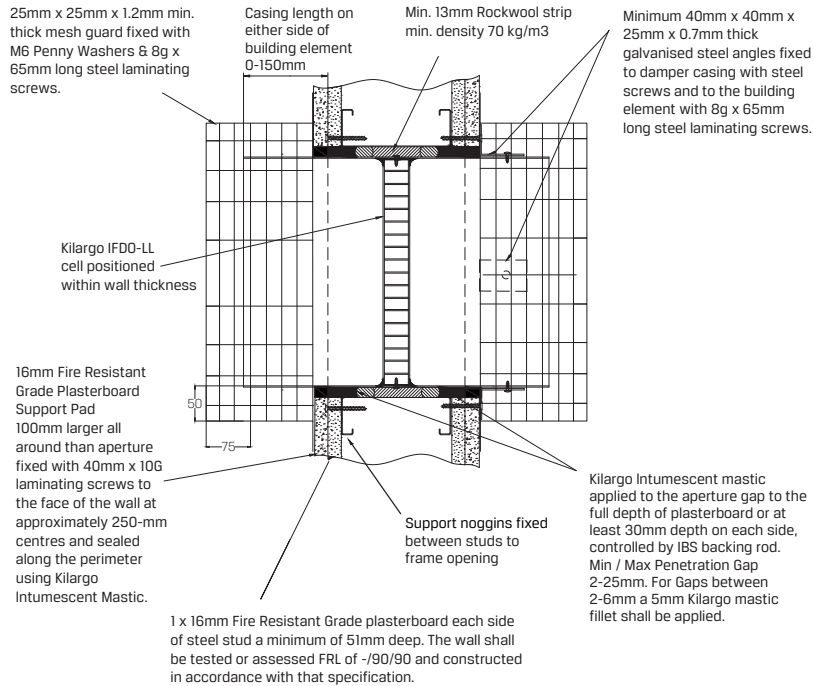

- Step 1** Fix additional plasterboard pads to each side of wall and apply Kilargo Intumescent Mastic to the edges as per system drawing.
- Step 2** Position damper centrally in penetration aperture as per system drawing with 70kg/m3 rockwool.
- Step 3** Fasten mounting brackets to damper with steel self-drilling screws or steel pop rivets and to the building element with appropriate mechanical fixings as per system drawing.
- Step 4** Apply Kilargo Intumescent Mastic (supplied separately) to the gaps between the damper & building element. Ensure fill depth corresponds with those detailed in the system drawing.
- Step 5** Ensure product and certification labels are in a prominent position for easy identification during subsequent maintenance inspections.
- Step 6** Fix 25 x 25 x 1.2mm thick mesh guards to each side of the building element with M6 penny washers & appropriate 8g x 65 fixings to suit as shown.

### System Notes

- Mesh guards, additional plasterboard pads, rockwool & fixings are to be supplied by others.
- Kilargo Intumescent Fire Dampers shall be installed in accordance with this detail, including the use of Kilargo Intumescent Mastic and in accordance with the requirements of AS1682.2
- Ensure convenient access is provided for visual inspection and cleaning as necessary
- 2mm Minimum gap allowable between damper and aperture. For gaps between 2-6mm, a fillet of Kilargo Intumescent Mastic shall be applied

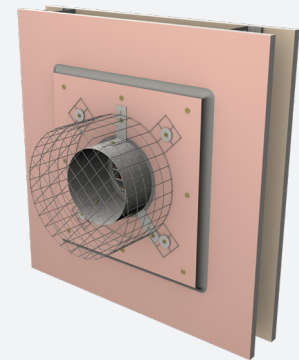

Building element: FR Plasterboard 1 x 16

Application: Transfer Air with mesh guard

Maximum size: 350 DIA

FRL -/90/90

Test reference No. FCO 3344

System No. WP13i

## Installation Instructions: Air Transfer

Wall Mounted Systems

### Plasterboard Pad Installation

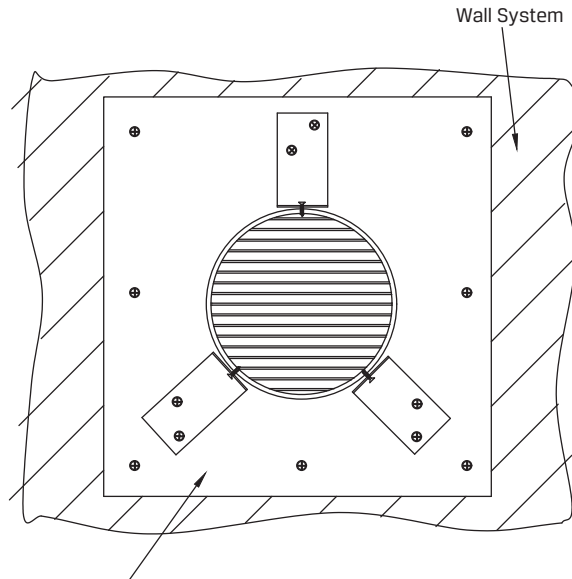

16mm Fire Resistant Grade Plasterboard support pad 100mm larger all around than aperture fixed with 40mm x 10G laminating screws to face of the wall at approximately 250mm centres and sealed along the perimeter with 6mm fillet of Kilargo Intumescent Mastic.

### Alternative Fixing Method

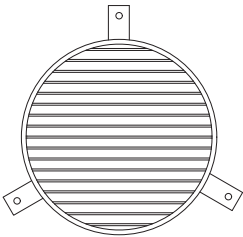

3 Off Angle brackets for sizes up to 200mm dia

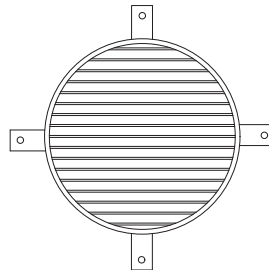

4 Off Angle brackets for sizes 250mm dia and over

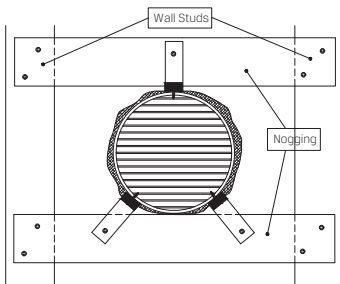

Guard Removed for clarity  
FACE FIXING  
Alternative fixing method Kilargo Intumescent fire damper supported by studs noggins fixed to

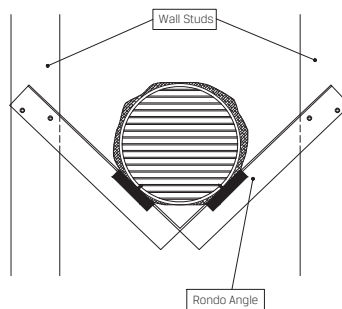

Guard Removed for clarity  
FACE FIXING  
Alternative fixing method Kilargo Intumescent fire damper supported by external Rondo angle hung between studs

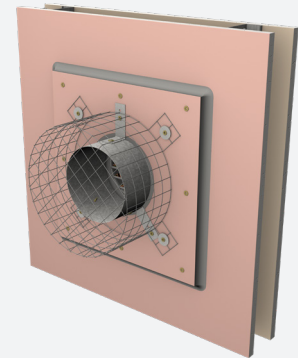

Building element: FR Plasterboard 1 x 16

Application: Transfer Air with mesh guard

Maximum size: 350 DIA

FRL -/90/90

Test reference No. FCO 3344

**System No. WP13i**