



Designed by:

SAFEHINGE SIMPLY DIFFERENT

ALUmini
The latest in
door safety







There's no catch

At Kilargo, we create, innovate and update to maximise building safety.





ALUmini is a durable and stylish retrofit finger guard that prevents fingers from becoming trapped.

The specialty product is part of Kilargo's architectural seals range and proves more effective than alternatives by filling the hinge gap rather than simply covering it.

ALUmini is:

-  **Slimline**
Taking up just 80mm of space on the door and works on doors with a stile as little as 90mm
-  **Versatile**
It can be fitted to most doors, including retro-fitting to older frames
-  **Flexible**
Offering an 180° opening angle
-  **Quick**
Taking less than five minutes to install
-  **Subtle**
There's almost no impact on the clear opening width



-  **Good looking**
The sleek aluminium finish complements most existing decor
-  **Durable**
Its robust construction can withstand heavy impacts
-  **Long-lasting**
The quality manufacture means it lasts longer than other finger guards
-  **Safe**
Through its innovative circular profile and retracting fabric

Specification

ALUmini – for push side of door

ALUmini IS9570

Gap-filling aluminium and fabric retrofit finger guard for doors.

Retrofit finger guard with patented gap-filling, finger ejection system (offering improved safety).

Durable aluminium body and fabric finger ejection system, 1925mm long, for 44mm door opening up to 180°.

As standard - SAA finish, charcoal-grey retracting fabric, including screw fixings.

Supplier

Kilargo Pty Ltd.



See how it works by visiting
www.kilargo.com.au

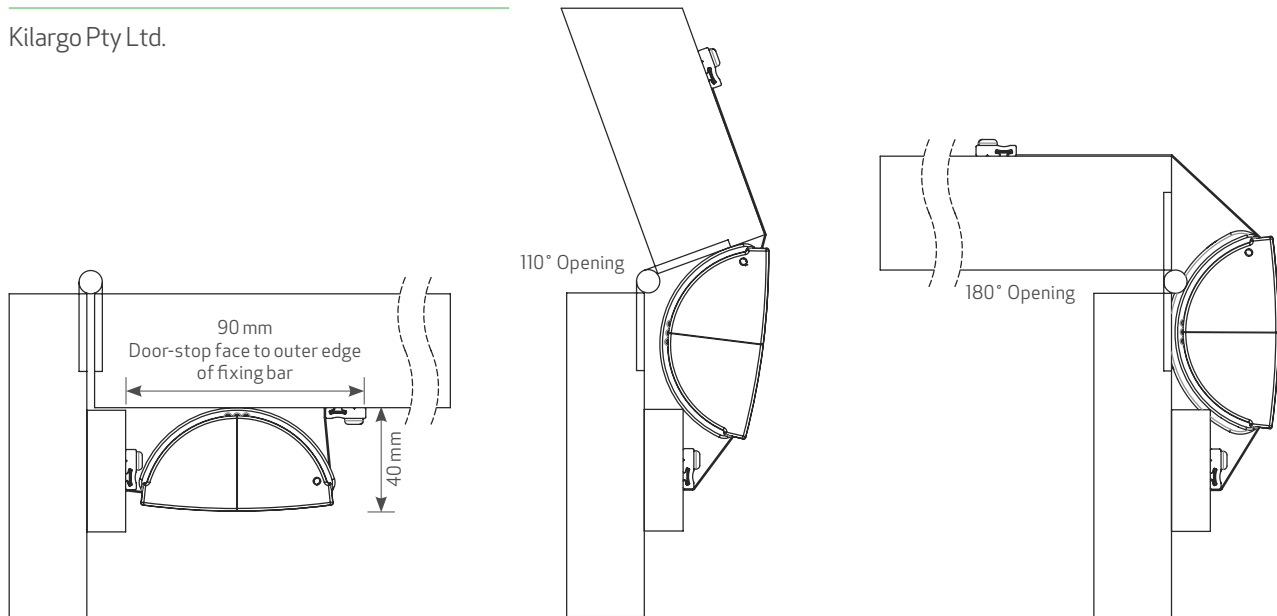



Designed by:

SAFEHINGE SIMPLY DIFFERENT

Let's talk

We'd love to help you make the right choice.

Call us on **1300 858 010**
visit www.kilargo.com.au
or email us at info@kilargo.com.au